

Coaxial Straight Flange Connector: SMA-KFD75

Description

Straight panel receptacle jack (female), flange mount

Interface standards

MIL-C-39012

Technical Data

Electrical Data

Impedance	50 Ω
Interface frequency max.	18 GHz
VSWR	1.05+0.01 \times f(GHz) max
Voltage rating	500 V(rms)
Test voltage	1000 V(rms)
Contact resistance:	
Center conductor	\leq 3m Ω
Out conductor	\leq 2m Ω
Insulation resistance	\geq 5000M Ω

Mechanical Data

Weight	2.3 g
Durability	500 Cycles

Environmental Data

Operating Temperature	-65 $^{\circ}$ C to 165 $^{\circ}$ C
-----------------------	--------------------------------------

Material Data

Piece Parts

Piece Parts	Material
Body	Brass
Center contact	Beryllium copper
Insulator	PTFE

Surface Plating(μ m)

Body	Gold 0.2 over Nickel 2.0
Center contact	Gold 0.5 over Nickel 2.0

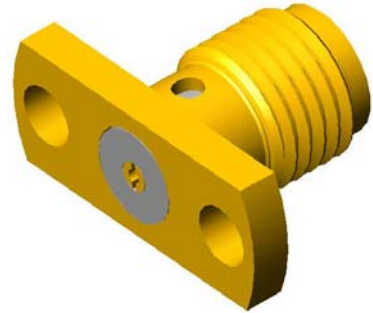

Coaxial Straight Flange Connector: SMA-KFD75

Outline drawing

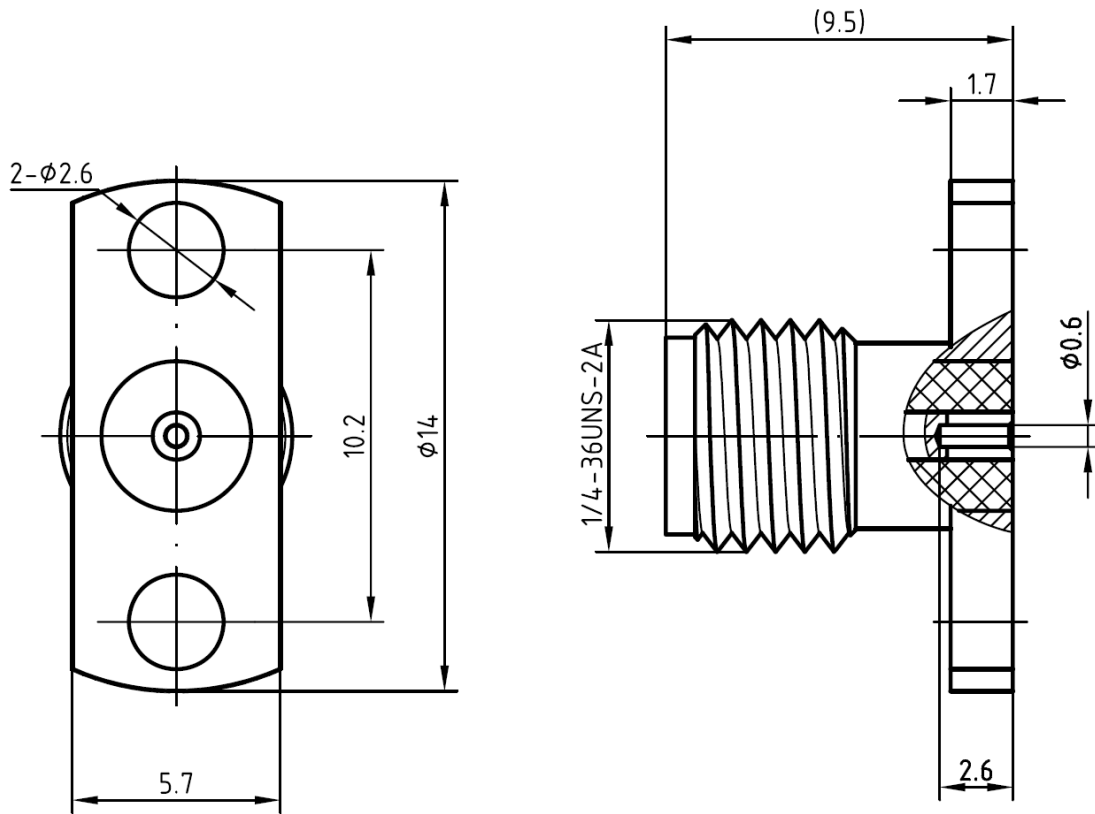

Packaging

Standard

150/Box=15 Bag

Other

Contact us