

Coaxial Straight Flange Connector: SMA-KFD32

Description

Straight panel receptacle jack (female), flange mount

Interface standards

MIL-C-39012

Technical Data

Electrical Data

Impedance	50 Ω
Interface frequency max.	18 GHz
VSWR	$1.05+0.01 \times f(\text{GHz})$ max
Voltage rating	500 V(rms)
Test voltage	1000 V(rms)
Contact resistance:	
Center conductor	$\leq 3\text{m} \Omega$
Out conductor	$\leq 2\text{m} \Omega$
Insulation resistance	$\geq 5000\text{M} \Omega$

Mechanical Data

Weight	3.1 g
Durability	500 Cycles

Environmental Data

Operating Temperature	-65 °C to 165 °C
-----------------------	------------------

Material Data

Piece Parts

Piece Parts	Material
Body	Brass
Center contact	Beryllium copper
Insulator	PTFE

Surface Plating(μm)

Gold 0.2 over Nickel 2.0
Gold 0.5 over Nickel 2.0

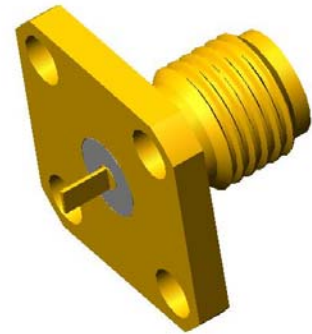

Coaxial Straight Flange Connector: SMA-KFD32

Outline drawing

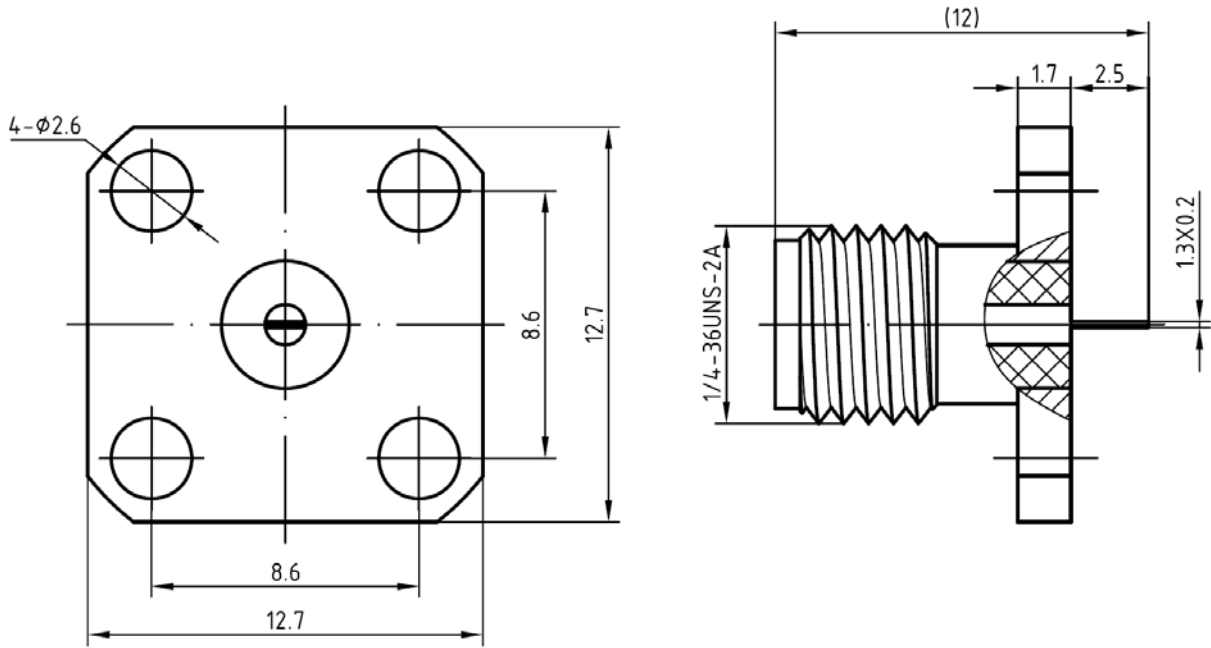

Packaging

Standard

100/Box=10 Bag

Other

Contact us