

Coaxial Cable Connector: MCX-J3

Description

MCX Straight cable plug for Flexible cable RG316

Interface standards

MIL-C-39012

Technical Data

Electrical Data

Impedance	50 Ω
Interface frequency max.	6 GHz
VSWR	1.10+0.05 \times f(GHz) max
Voltage rating	335 V(rms)
Test voltage	750 V(rms)
Contact resistance:	
Center conductor	\leq 5 m Ω
Out conductor	\leq 2.5 m Ω
Insulation resistance	\geq 1000M Ω

Mechanical Data

Weight	1.6 g
Durability	500 Cycles

Environmental Data

Operating Temperature	-65 $^{\circ}$ C to 165 $^{\circ}$ C
-----------------------	--------------------------------------

Material Data

Piece Parts

Center contact	Brass
Spring contacts	Beryllium copper
Body	Brass
Crimp ferrules	Copper alloy
Insulator	PTFE

Material

Surface Plating(μ m)

Gold 0.5 over Nickel 2.0
Gold 0.5 over Nickel 2.0
Gold 0.2 over Nickel 2.0
Nickel 7.0 over copper 2.0

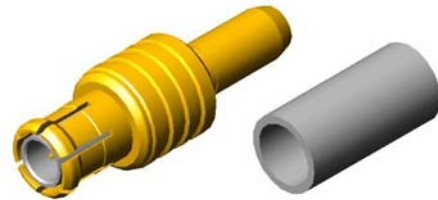

Coaxial Cable Connector: MCX-J3

Outline drawing

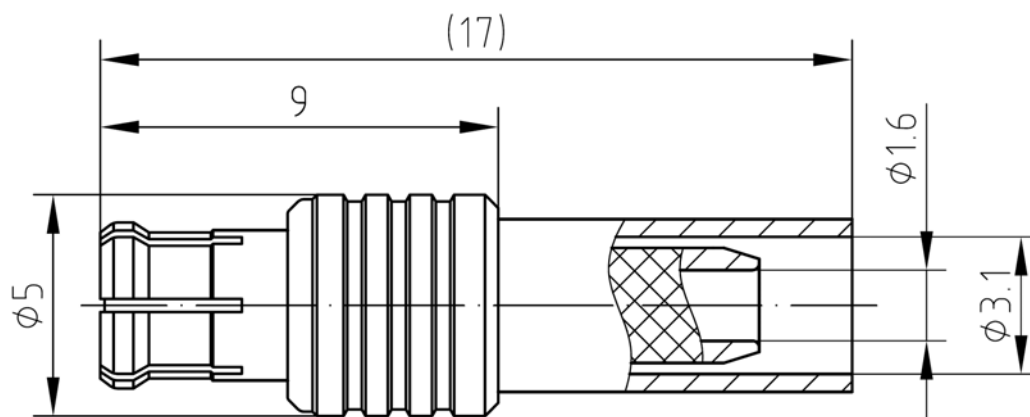

Packaging

Standard

200/Box=20 Bag

Other

Contact us