

Coaxial Straight Flange Connector: SMA-JFD7

Description

Straight panel receptacle plug (male), flange mount

Interface standards

MIL-C-39012

Technical Data

Electrical Data

Impedance	50 Ω
Interface frequency max.	18 GHz
VSWR	$1.05+0.01 \times f(\text{GHz})$ max
Voltage rating	500 V(rms)
Test voltage	1000 V(rms)
Contact resistance:	
Center conductor	$\leq 3\text{m } \Omega$
Out conductor	$\leq 2\text{m } \Omega$
Insulation resistance	$\geq 5000\text{M } \Omega$

Mechanical Data

Weight	3.3 g
Durability	500 Cycles

Environmental Data

Operating Temperature	-65 °C to 165 °C
-----------------------	------------------

Material Data

Piece Parts

Center contact	Beryllium copper
Body	Brass
Coupling nut	Brass
Gasket	Silicone Rubber
Insulator	PTFE

Material

Surface Plating(μm)

Gold 0.5 over Nickel 2.0
Gold 0.2 over Nickel 2.0
Gold 0.2 over Nickel 2.0

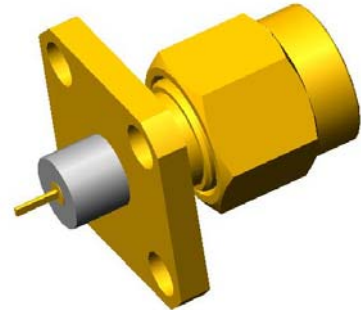

Coaxial Straight Flange Connector: SMA-JFD7

Outline drawing

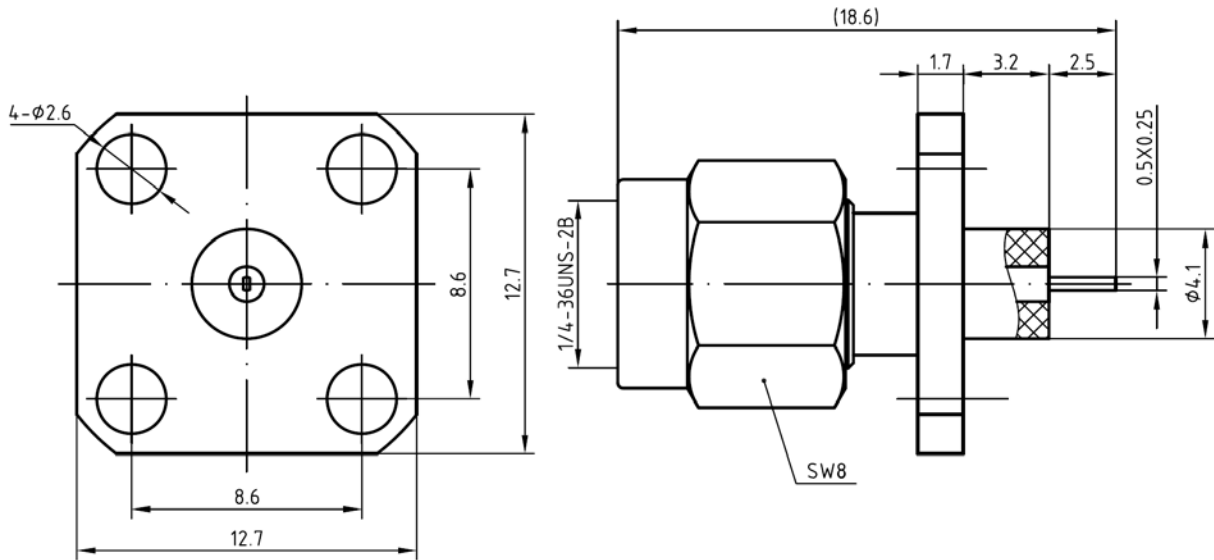

Packaging

Standard

100/Box=10 Bag

Other

Contact us