

# Attenuator

## SMA 2W 3dB 18G Attenuator, Stainless Steel

P.N. : F01-B1803-03

### Products feature

- Reliable Attenuation & V.S.W.R
- Easy maintenance
- Wide broadband frequency application
- Directional 2 watt rating

### Electrical specification

Item	Specification
Frequency Range	DC ~ 18 GHz
Impedance (Nominal)	50Ω
Average Power Rating	2 Watt
Peak Power(5 μs)	0.25 KW
Attenuation	3 dB +/- 0.8dB/max
V.S.W.R (Max)	1.30 : 1
Temperature Range	-55°C~ 85°C
Connector Type	SMA male(Input) – female(Output)
RoHS	Compliant

### Material specification

Item	Specification
Connector	Stainless Steel / Passivated
Body	Stainless Steel / Passivated

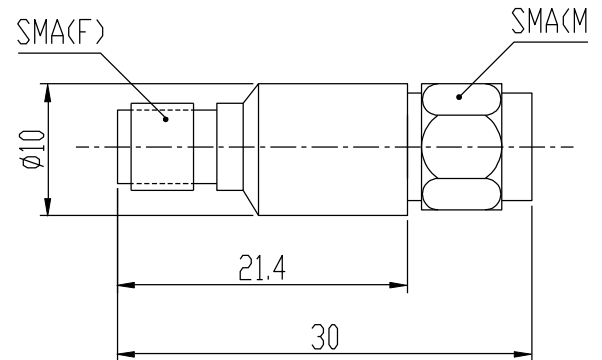

### Electrical performance

