

Coaxial Straight PCB Connector: MCX-KHD3

Description

Straight jack receptacle for PCB solder legs

Interface standards

MIL-C-39012

Technical Data

Electrical Data

Impedance	50 Ω
Interface frequency max.	6 GHz
VSWR	1.05+0.05 \times f(GHz) max
Voltage rating	335 V(rms)
Test voltage	750 V(rms)
Contact resistance:	
Center conductor	\leq 5 m Ω
Out conductor	\leq 2.5 m Ω
Insulation resistance	\geq 1000M Ω

Mechanical Data

Weight	1.0 g
Durability	500 Cycles

Environmental Data

Operating Temperature	-65 $^{\circ}$ C to 165 $^{\circ}$ C
-----------------------	--------------------------------------

Material Data

Piece Parts

Center contact	Beryllium copper
Body	Brass
Insulator	PTFE

Surface Plating(μ m)

Gold 0.5 over Nickel 2.0
Gold 0.2 over Nickel 2.0

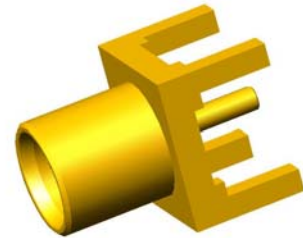

Coaxial Straight PCB Connector: MCX-KHD3

Outline drawing

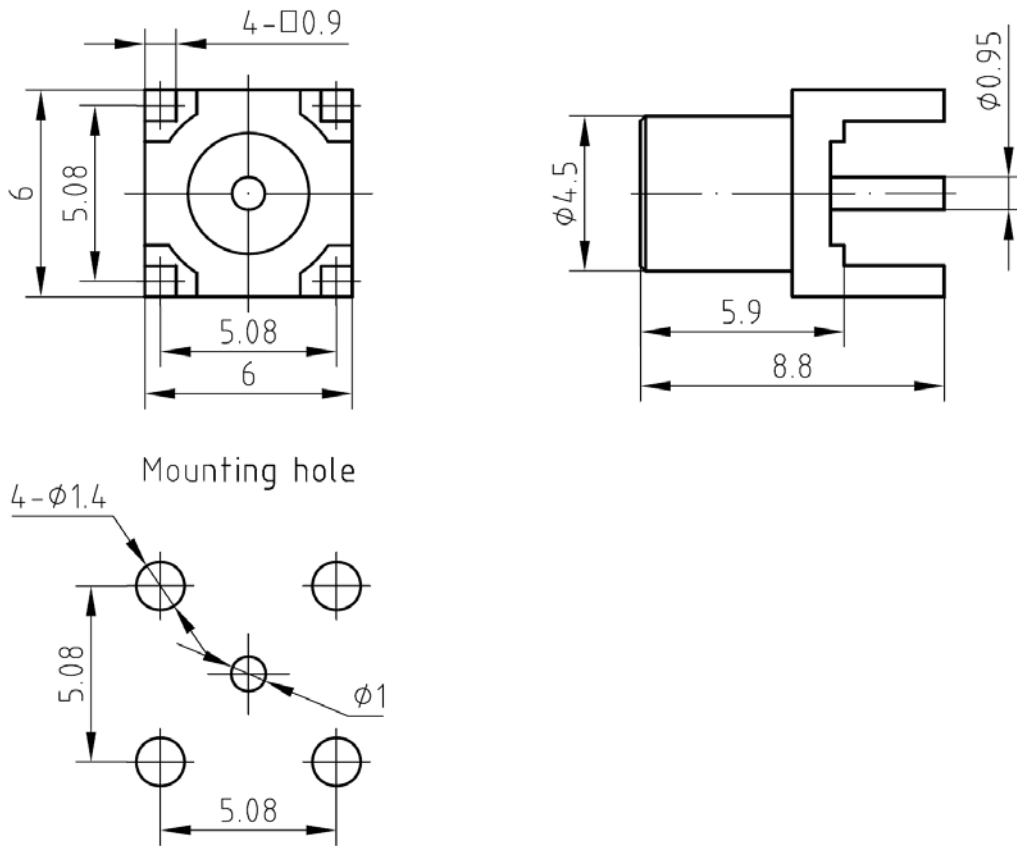

Packaging

Standard

200/Box=20 Bag

Other

Contact us