

## Coaxial Straight Bulkhead Connector: SMA-KY4

### Description

Straight bulkhead jack for Flexible cable

### Interface standards

MIL-C-39012

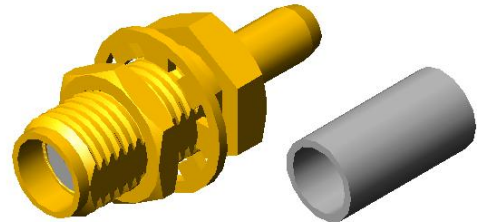

### Technical Data

#### Electrical Data

Impedance	50 $\Omega$
Interface frequency max.	12.4 GHz
VSWR	1.10+0.025 $\times$ f(GHz) max
Voltage rating	500 V(rms)
Test voltage	1000 V(rms)
Contact resistance:	
Center conductor	$\leq 3$ m $\Omega$
Out conductor	$\leq 2$ m $\Omega$
Insulation resistance	$\geq 5000$ M $\Omega$

#### Mechanical Data

Weight	4.6 g
Durability	500 Cycles

#### Environmental Data

Operating Temperature	-65 $^{\circ}$ C to 165 $^{\circ}$ C
-----------------------	--------------------------------------

#### Material Data

##### Piece Parts

Center contact  
Body  
Coupling nut  
Insulator  
Crimp ferrules

##### Material

Beryllium copper  
Brass  
Brass  
PTFE  
Brass

##### Surface Plating( $\mu$ m)

Gold 0.5 over Nickel 2.0  
Gold 0.2 over Nickel 2.0  
Gold 0.2 over Nickel 2.0  
Nickel 7.0 over copper 2.0

# Coaxial Straight Bulkhead Connector: SMA-KY4

## Outline drawing

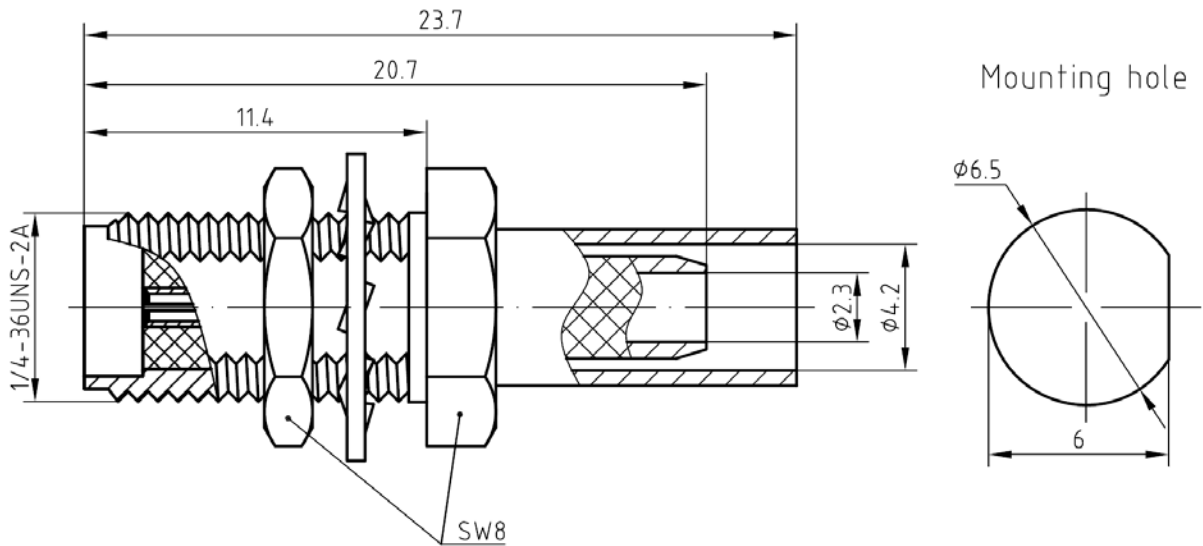

## Packaging

Standard

100/Box=10 Bag

Other

Contact us