

Coaxial Cable Connector: SSMA-KFB2

Description

SSMA Straight square flange jack solder type cable .086

Interface standards

MIL-C-39012

Technical Data

Electrical Data

Impedance	50 Ω
Interface frequency max.	26.5 GHz
VSWR	1.05+0.015 \times f(GHz) max
Voltage rating	500 V(rms)
Test voltage	750 V(rms)
Contact resistance:	
Center conductor	$\leq 3\text{m } \Omega$
Out conductor	$\leq 2\text{m } \Omega$
Insulation resistance	$\geq 5000\text{M } \Omega$

Mechanical Data

Weight	1.9 g
Durability	500 Cycles

Environmental Data

Operating Temperature	-65 $^{\circ}\text{C}$ to 165 $^{\circ}\text{C}$
-----------------------	--

Material Data

Piece Parts

Center contact	Beryllium copper
Body	Brass
Insulator	PTFE

Surface Plating(μm)

Gold 0.5 over Nickel 2.0
Gold 0.2 over Nickel 2.0

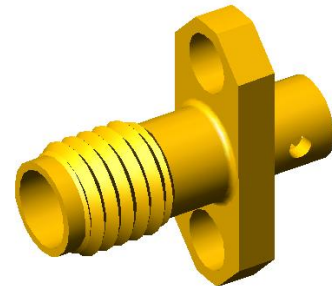

Coaxial Cable Connector: SSMA-KFB2

Outline drawing

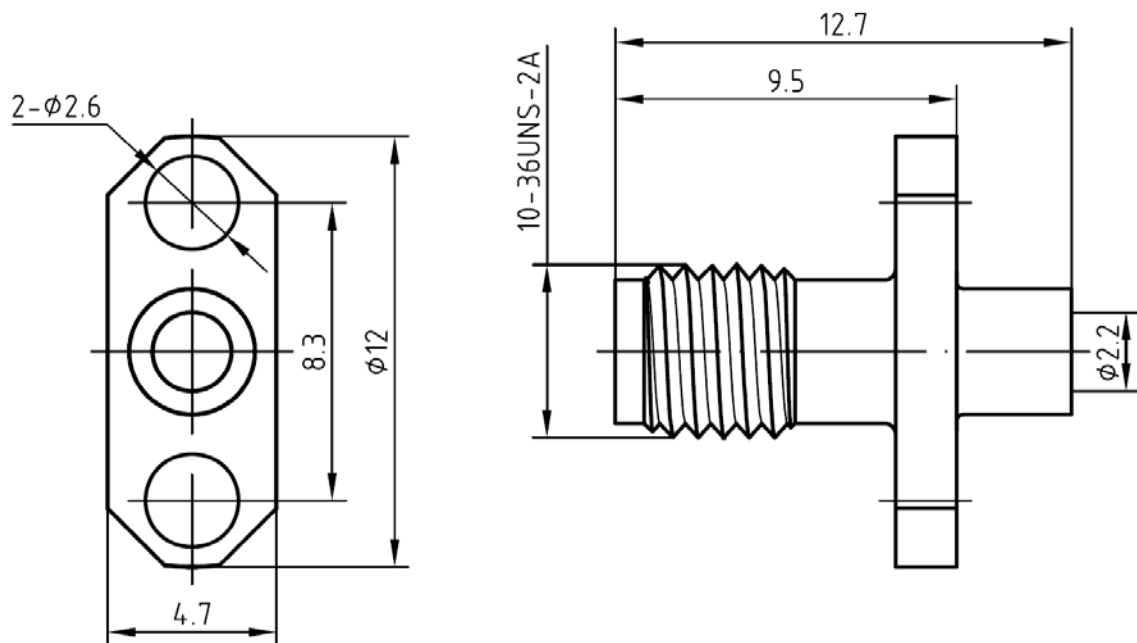

Packaging

Standard

200/Box=20 Bag

Other

Contact us