

Coaxial Straight Flange Connector: SMA-KFD31

Description

Straight panel receptacle jack (female), flange mount

Interface standards

MIL-C-39012

Technical Data

Electrical Data

Impedance	50 Ω
Interface frequency max.	18 GHz
VSWR	$1.05+0.01 \times f(\text{GHz})$ max
Voltage rating	500 V(rms)
Test voltage	1000 V(rms)
Contact resistance:	
Center conductor	$\leq 3\text{m} \Omega$
Out conductor	$\leq 2\text{m} \Omega$
Insulation resistance	$\geq 5000\text{M} \Omega$

Mechanical Data

Weight	2.8 g
Durability	500 Cycles

Environmental Data

Operating Temperature	-65 °C to 165 °C
-----------------------	------------------

Material Data

Piece Parts

Body	Brass
Center contact	Beryllium copper
Insulator	PTFE

Surface Plating(μm)

Gold 0.2 over Nickel 2.0
Gold 0.5 over Nickel 2.0

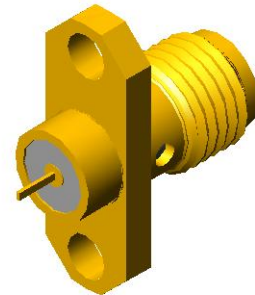

Coaxial Straight Flange Connector: SMA-KFD31

Outline drawing

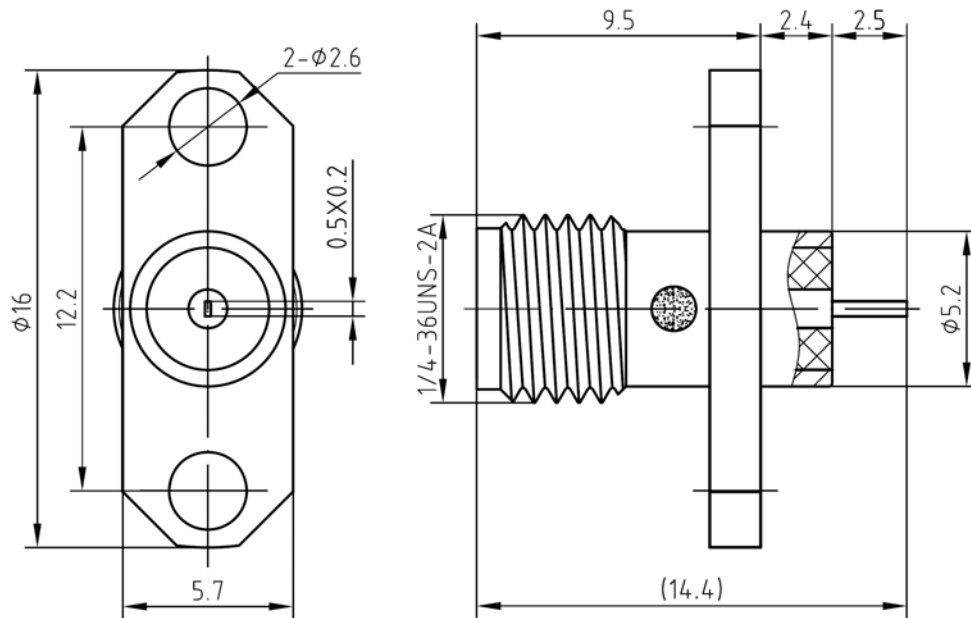

Packaging

Standard

100/Box=10 Bag

Other

Contact us