

# Coaxial Straight Flange Connector: SMA-KFD13

## Description

Straight panel receptacle jack (female), flange mount

## Interface standards

MIL-C-39012

## Technical Data

### Electrical Data

Impedance	50 $\Omega$
Interface frequency max.	18 GHz
VSWR	1.05+0.01 $\times$ f(GHz) max
Voltage rating	500 V(rms)
Test voltage	1000 V(rms)
Contact resistance:	
Center conductor	$\leq 3\text{m } \Omega$
Out conductor	$\leq 2\text{m } \Omega$
Insulation resistance	$\geq 5000\text{M } \Omega$

### Mechanical Data

Weight	3.3 g
Durability	500 Cycles

### Environmental Data

Operating Temperature	-65 $^{\circ}\text{C}$ to 165 $^{\circ}\text{C}$
-----------------------	--

### Material Data

#### Piece Parts

Body	Brass
Center contact	Beryllium copper
Insulator	PTFE

#### Surface Plating( $\mu\text{m}$ )

Gold 0.2 over Nickel 2.0
Gold 0.5 over Nickel 2.0

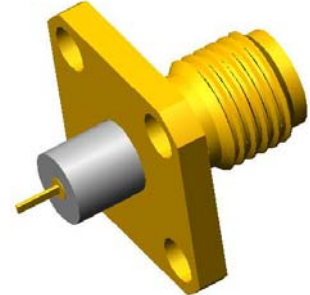

# Coaxial Straight Flange Connector: SMA-KFD13

## Outline drawing

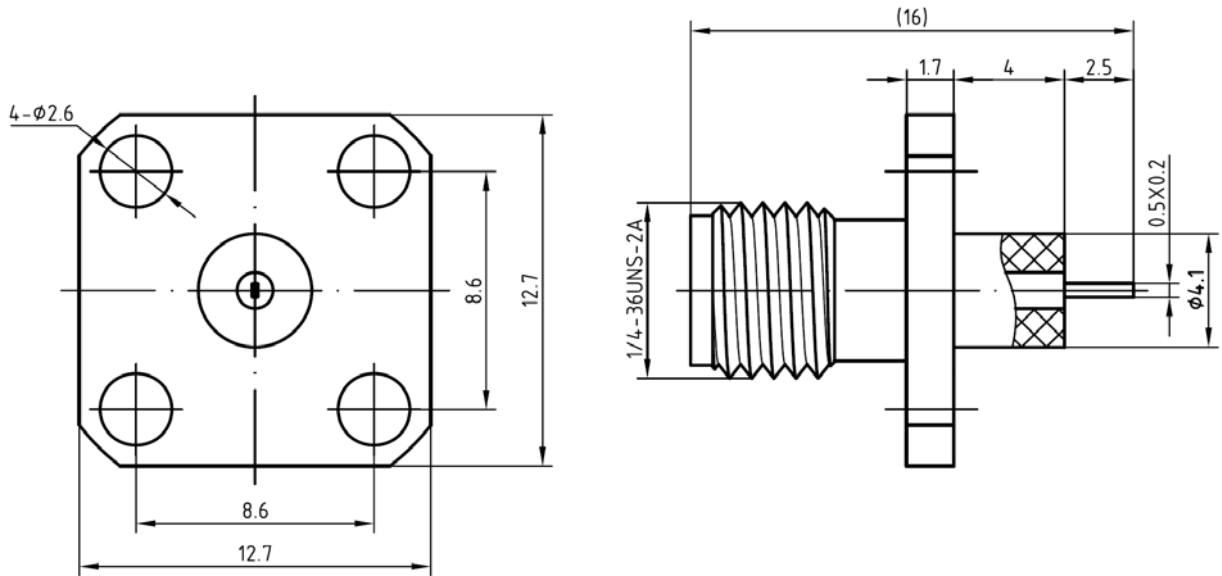

## Packaging

Standard

100/Box=10 Bag

Other

Contact us