

Coaxial Straight Flange Connector: SMA-KFD178

Description

Straight panel receptacle jack (female), flange mount

Interface standards

MIL-C-39012

Technical Data

Electrical Data

| | |
|--------------------------|-------------------------------|
| Impedance | 50 Ω |
| Interface frequency max. | 18 GHz |
| VSWR | 1.05+0.01 \times f(GHz) max |
| Voltage rating | 500 V(rms) |
| Test voltage | 1000 V(rms) |
| Contact resistance: | |
| Center conductor | $\leq 3\text{m } \Omega$ |
| Out conductor | $\leq 2\text{m } \Omega$ |
| Insulation resistance | $\geq 5000\text{M } \Omega$ |

Mechanical Data

| | |
|------------|------------|
| Weight | 3.2 g |
| Durability | 500 Cycles |

Environmental Data

| | |
|-----------------------|--|
| Operating Temperature | -65 $^{\circ}\text{C}$ to 165 $^{\circ}\text{C}$ |
|-----------------------|--|

Material Data

Piece Parts

| | |
|----------------|------------------|
| Body | Brass |
| Center contact | Beryllium copper |
| Insulator | PTFE |

Surface Plating(μm)

| |
|--------------------------|
| Gold 0.2 over Nickel 2.0 |
| Gold 0.5 over Nickel 2.0 |

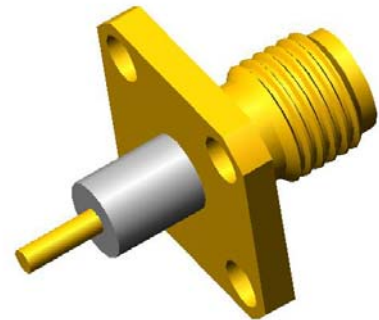

Coaxial Straight Flange Connector: SMA-KFD178

Outline drawing

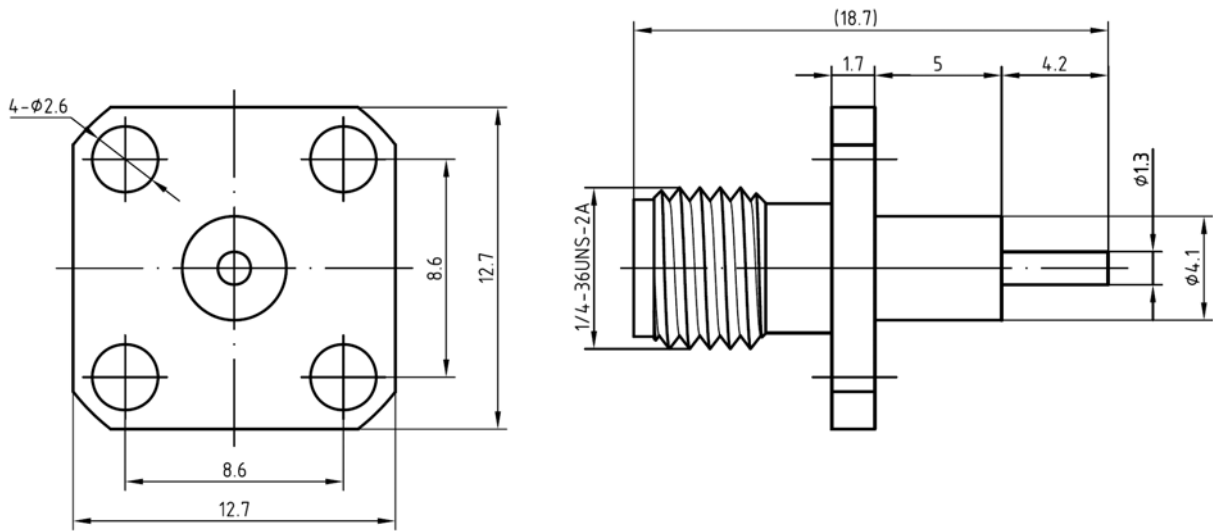

Packaging

Standard

100/Box=10 Bag

Other

Contact us