

DRAWING

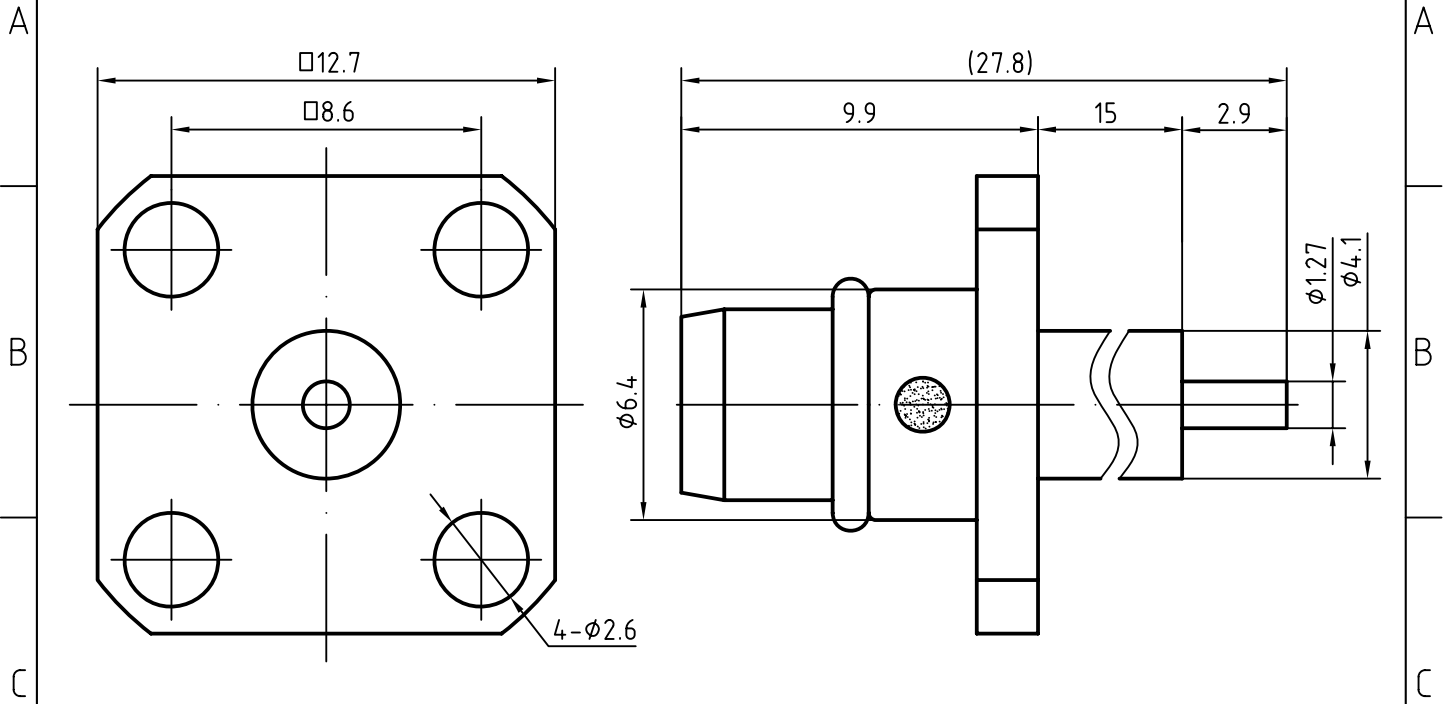

MOUNTING HOLE

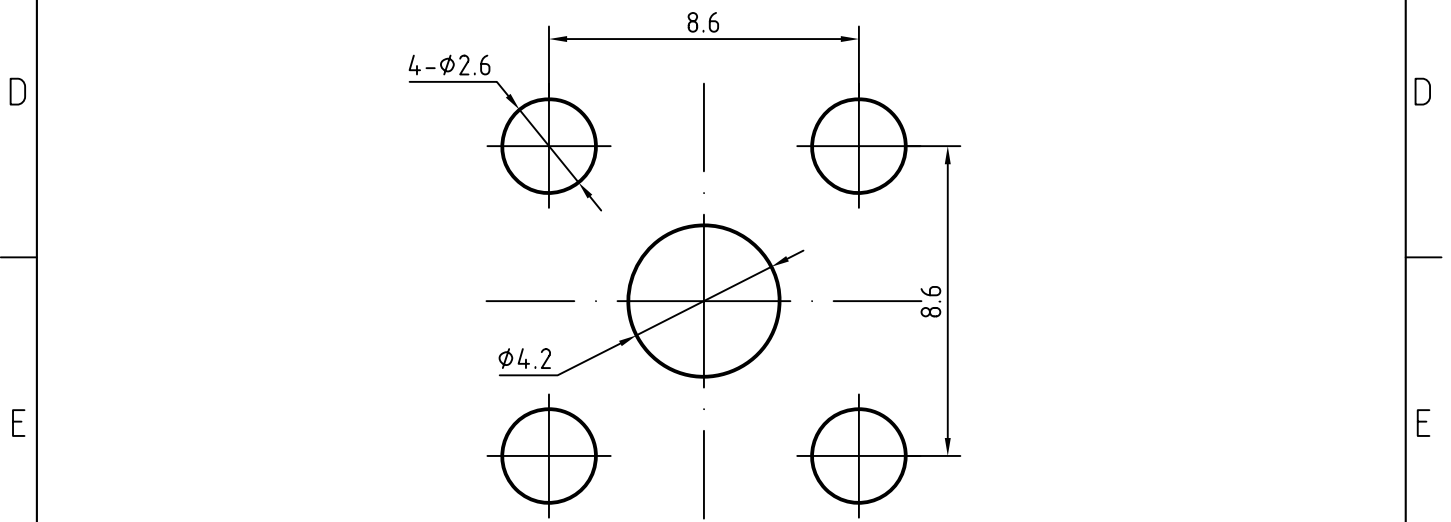

3	1	Body	Brass/Gold plated	Gold 0.2um over Nickel 2um
2	1	Insulator	PTFE	
1	1	Center contact	Brass/Gold plated	Gold 0.5um over Nickel 2um

Designed by Mingang Han	Checked by Jinlong Gu	Approved by - date Hongyu Du	File name BMA-JFD3	Date 07.08.17	Scale 1 : 1
----------------------------	--------------------------	---------------------------------	-----------------------	------------------	----------------

Amitron Electronics, Ltd.	BMA-JFD3		
	http://www.amel.ru	Edition 1.0	Sheet 1/1

CHARACTERISTICS

DESCRIPTION: BMA Type female FL connector(4 holes)

Electrical data:

<i>Impedance:</i>	50 ohm
<i>Frequency range:</i>	DC to 18 GHz
<i>VSWR:</i>	$\leq 1.07 + 0.015Xf[\text{GHz}]$
<i>Insertion loss:</i>	$\leq 0.08X\sqrt{f[\text{GHz}]} \text{ dB}$
<i>Insulation resistance:</i>	$\geq 5000\text{M}\Omega$
<i>Test voltage:</i>	750 V rms
<i>Working voltage:</i>	480 V rms
<i>Contact resistance:</i>	
1). Centre contact:	3.0 m Ω
2). Outer conductor:	2.0 m Ω

Environmental data:

<i>Temperature rating:</i>	-65 ° C to +125 ° C
<i>2002/95/EC (RoHS):</i>	Compliant

Mechanical data:

<i>Mating cycles:</i>	≥ 500
-----------------------	------------

Suitable cables:

N/A