

Coaxial Straight Flange Connector: N-KFD2

Description

Straight panel receptacle jack (female), flange mount

Interface standards

MIL-C-39012

Technical Data

Electrical Data

Impedance	50 Ω
Interface frequency max.	11 GHz
VSWR	$1.05 + 0.02 \times f$ (GHz) max
Voltage rating	1000 V(rms)
Test voltage	1500 V(rms)
Contact resistance:	
Center conductor	$\leq 1\text{m} \Omega$
Out conductor	$\leq 0.2\text{m} \Omega$
Insulation resistance	$\geq 5000\text{M} \Omega$

Mechanical Data

Center contact retention	
Axial force – Mating end	27 N mini
Axial force – Opposite end	27 N mini
Torque	2.8 N.cm mini
Weight	30 g
Durability	500 Cycles

Environmental Data

Operating Temperature	-65 °C to 165 °C
-----------------------	------------------

Material Data

Piece Parts

	Material	Surface Plating(μm)
Center contact	Phosphor bronze	Gold 0.3 over Nickel 2.0
Outer contact	Brass	Nickel 7.0 over copper 2.0
Insulator	PTFE	

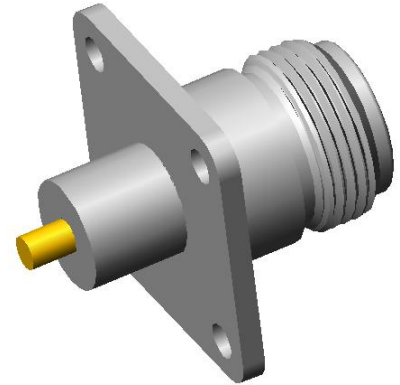

Coaxial Straight Flange Connector: N-KFD2

Outline drawing

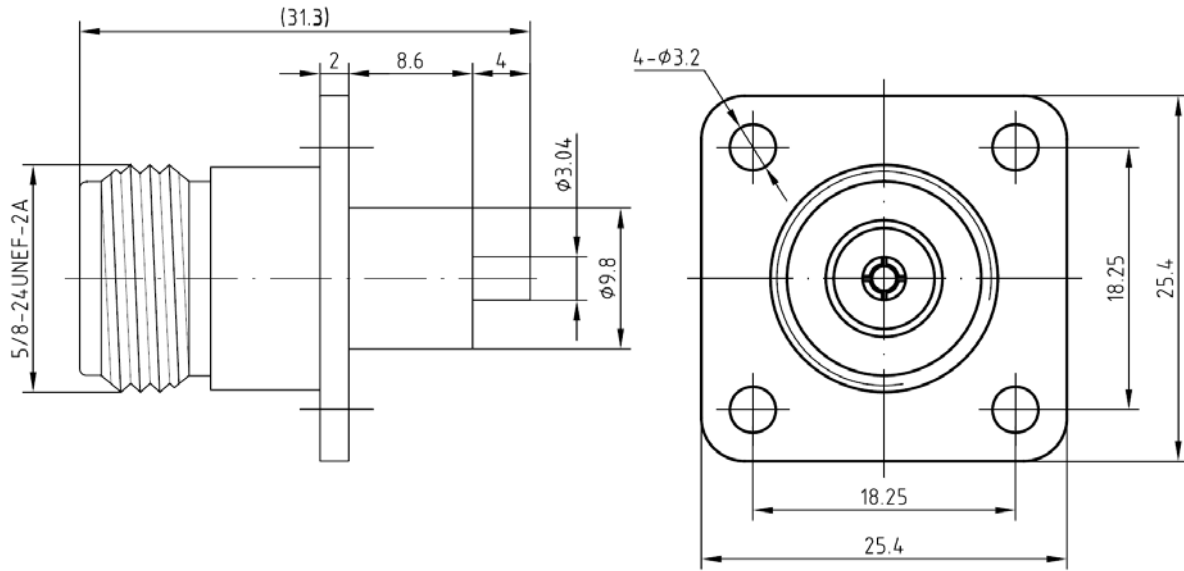

Packaging

Standard

40/Box=4Bag

Other

Contact us